

# Dental Excellence in every area



## Practice equipment

KaVo treatment units and lights, dental chairs, patient communication systems, dental microscope and additional operatory accessories.



## Instruments

Dental straight and contra-angle handpieces, turbines, air polishing systems and small equipment for all application areas including diagnosis, prophylaxis, restorative, surgery, endodontics and instrument care.



## Imaging

Intraoral X-ray equipment, sensors and imaging plate systems, panoramic and cephalometric in combination with CBCT, as well as dedicated CBCT devices for every indication in dentistry.



## CAD/CAM

Dental CAD/CAM solutions for premium aesthetic, natural-looking and long-lasting restorative work, suitable for dentists and dental technicians.

The products, features and services shown and described in this catalogue are not available in all countries. All specifications were correct at the time of publication. KaVo Dental GmbH assumes no liability for deviations in colour or form from the illustrations, mistakes or printing errors and reserves the right to make changes to the brochures at any time. Reprinting, even just of excerpts, is only permitted with the consent of KaVo Dental GmbH.

ORTHOPANTOMOGRAPH™, OP™, OP 3D™, SMARTVIEW™, CliniView™, Low Dose Technology™, ORTHOfocus™, ORTHOselect™, ORTHOceph™ and QUICKcompose™ are either registered trademarks or trademarks of KaVo Kerr Group Finland in the United States and/or other countries. KaVo™ is either registered trademark or trademark of Kaltenbach & Voigt GmbH in the United States and/or other countries. All other trademarks are property of their respective owners.

Palodex Group OY | Nahkelantie 160 | FI-04300 Tuusula | Finland  
www.kavokerr.com

KaVo Dental GmbH | Bismarckring 39 | 88400 Biberach | Germany  
www.kavo.com

**KAVO**  
Dental Excellence

## OP 3D™

Award-winning innovations for panoramic, cephalometric and 3D imaging



KV\_07\_1B\_0170\_REV1 © Copyright KaVo Dental GmbH.

**KAVO**  
Dental Excellence

## Welcome to excellent imaging: KaVo ORTHOPANTOMOGRAPH™ OP 3D

The KaVo OP 3D makes choosing your X-ray system simple. It is a complete X-ray platform that provides easy-to-use features throughout the entire dental imaging workflow. With its versatile imaging programs and intuitive user interface, the KaVo OP 3D in its different configurations offers imaging excellence for a variety of users, ranging from general dental practitioners to orthodontists, and all the way to maxillofacial surgeons.

OP 3D Vision

OP 3D Pro

**OP 3D**

### Panoramic

- Fast Scan – 2D panoramic imaging in just 9 seconds
- ORTHOfocus™ feature for providing the optimum panoramic image layer automatically
- Panoramic programs for covering the daily needs of a busy practice

### Cephalometric

- Innovative and patented ORTHOceph™ Plus design with fast cephalometric imaging scan times and adjustable field sizes for perfect image quality with minimal dose

### 3D

- 4 resolutions for 3D (Low Dose Technology™ (LDT), Standard, High, Endo) combined with Metal Artefact Reduction (MAR) technology
- 4 predefined volumes: 5x ø 5, 6x ø 9, 9x ø 11 and (optional) 9x ø 14 cm – thanks to SMARTVIEW™ 2.0 the volumes are freely positionable and height adjustable in 5 mm steps between 5 and 9 cm before the exposure, leading to up to 36 possible FOV sizes in total.

### Overall benefits

- QUICKcompose™ for fast image review, appearing automatically following the scan
- Optimised imaging workflows
- Configurable device platform: Panoramic, Cephalometric and 3D imaging
- Lead-free device

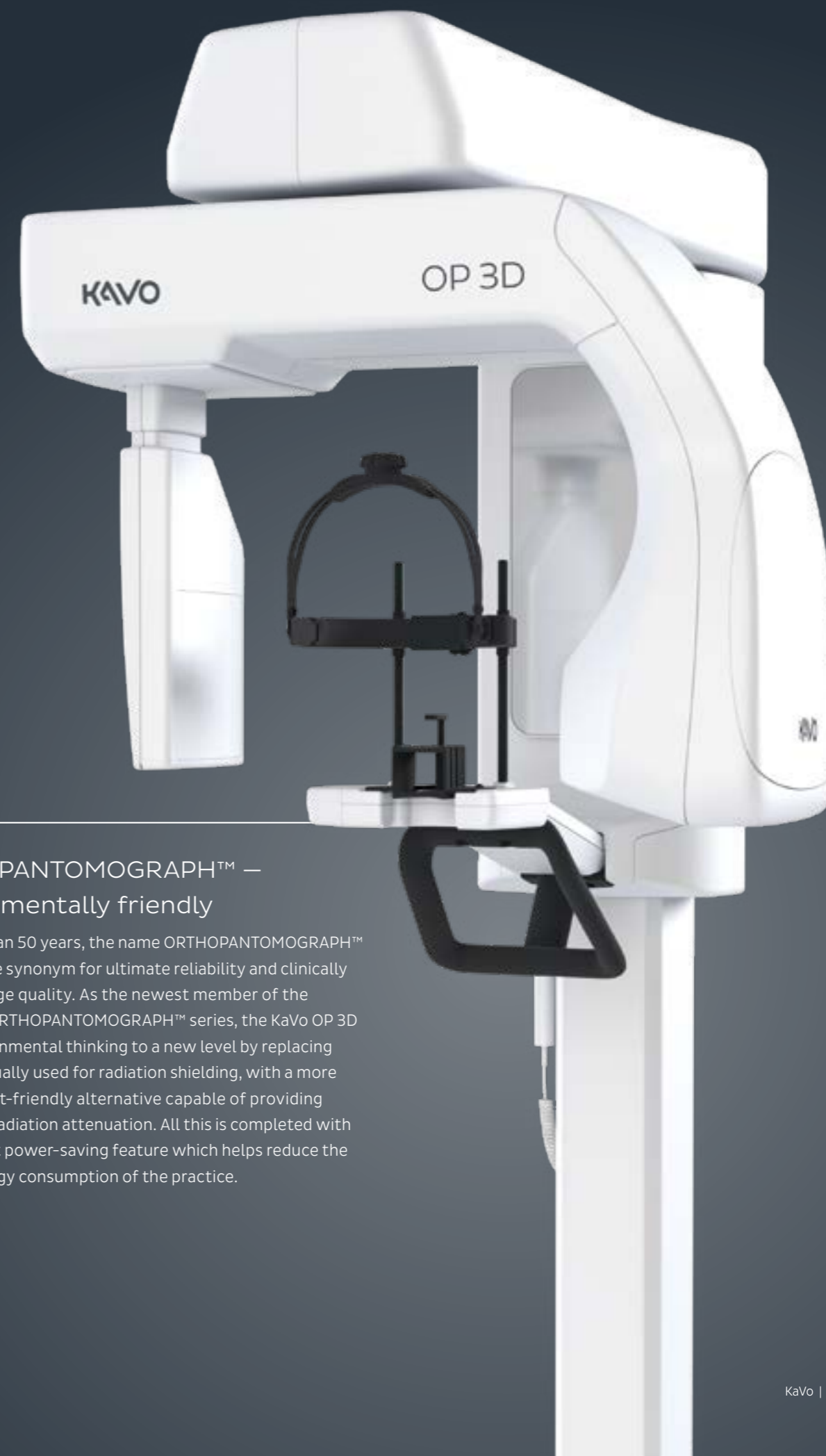

### ORTHOPANTOMOGRAPH™ — environmentally friendly

For more than 50 years, the name ORTHOPANTOMOGRAPH™ has been the synonym for ultimate reliability and clinically correct image quality. As the newest member of the legendary ORTHOPANTOMOGRAPH™ series, the KaVo OP 3D takes environmental thinking to a new level by replacing the lead, usually used for radiation shielding, with a more environment-friendly alternative capable of providing equivalent radiation attenuation. All this is completed with the efficient power-saving feature which helps reduce the overall energy consumption of the practice.

# Panoramic images with automatically selected optimum layer – ORTHOfocus™

## Programs to fit your clinical needs

Standard, paediatric and segmented panoramics along with bitewing and lateral-TMJ programs are included to cover the panoramic imaging needs of a busy practice. With the ORTHOfocus™ feature, the optimum panoramic image layer is automatically obtained, enabling forgiving patient positioning. The result is consistent image quality every time.



The standard panoramic program provides a clear definition of the dental anatomy, including TMJs – in only 9 seconds. This results in highly diagnostic images due to fewer movement artefacts as well as a lower dose to the patient.



The paediatric panoramic program has a clinically adapted image layer and reduced image height.

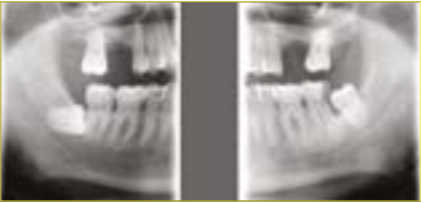

The bitewing program provides a quick and easy alternative to intraoral bitewing imaging.



The TMJ program provides a lateral view of temporomandibular joints, with an open or closed mouth.

## Cephalometric imaging innovations – for all your clinical needs

The innovative, patented ORTHOceph™ Plus design of the KaVo OP 3D takes cephalometric imaging workflow to a new level. The KaVo OP 3D provides all needed protocols such as lateral and paediatric lateral projections with adjustable field widths, posterior-anterior (PA) projections and carpus\* imaging – with fast scan times and a minimal dose. All combined with an intuitive graphical user interface and automated sensor movements to enable smooth workflows.



\* Carpus holder optional



Lateral cephalometric images provide rich anatomical details with exceptional visibility of the soft tissue borderline.



Paediatric lateral images with reduced height and minimal radiation exposure for the dose-sensitive paediatric patients



PA cephalometric images offer great details – thanks to the powerful dedicated X-ray source.



Carpus imaging information to determine patient age and growth

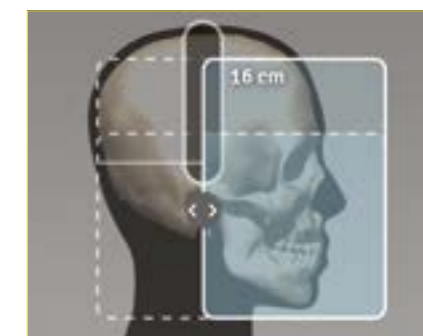

Lateral cephalometric programs for adult and paediatric patients with adjustable 16 to 26 cm fields width

### ORTHOceph™ Plus design

- Thanks to its patented design, the KaVo OP 3D is by definition at the correct height for a CEPH image if a panoramic image has been taken first. Due to the minimised needs for adjustments, workflows are easy and fast.
- A dedicated X-ray source for the cephalometric imaging, combined with advanced sensor technology, enables a high throughput and optimum imaging parameters resulting in clinically great results with minimal radiation exposure for the patient.

## Four predefined 3D volume diameters plus the possibility to customise the volume size

The four predefined FOVs of the KaVo OP 3D are based on true clinical needs and are adjustable in height. FOV 5x  $\emptyset$  5 cm with its endo resolution is optimised for single-tooth and localised diagnostics. FOV 6x  $\emptyset$  9 cm offers the capability of scanning either the lower or upper jaw, whereas FOV 9x  $\emptyset$  11 cm combines both. With the largest FOV 9x  $\emptyset$  14 cm, TMJs can be conducted.

### Low Dose Technology™ (LDT)



The LDT scan can be used in dose-sensitive cases and in control and follow-up scans where the dose is to be minimised or a lower resolution is acceptable.

### Standard resolution



The standard resolution scan with an optimised patient dose can be used for general diagnostics.

### Metal Artefact Reduction (MAR)

To provide optimum image quality, the Metal Artefact Reduction (MAR) is activated with all FOV sizes and resolutions of the KaVo OP 3D. MAR is optimised to assist in all cases ranging from endodontics and implants planning to maxillofacial imaging.

### High resolution



The high resolution scan offers extremely sharp images for more detailed diagnosis.

### Endo resolution



The endo resolution scan (available at  $\emptyset$  5 cm) with an 80  $\mu$ m voxel size is designed especially for endodontic applications.

## 5x $\emptyset$ 5 cm

### Local diagnostics

- Planning of individual implants
- Wisdom tooth extractions
- Impacted teeth
- With endo resolution for highly precise illustration of the canals and the periodontal structures

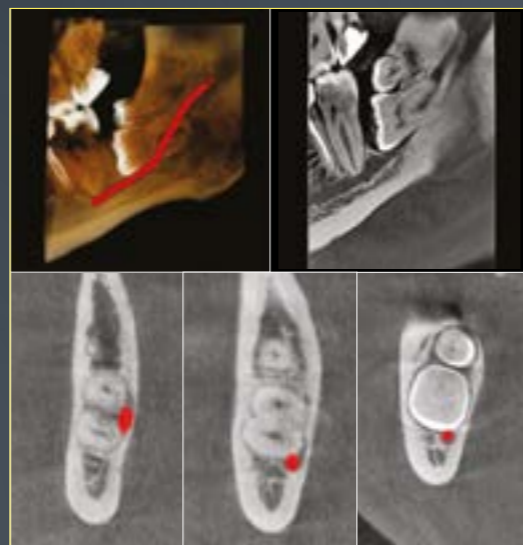

## 9x $\emptyset$ 11 cm

### Covers the entire dentition, including lower and upper jaw, as well as a portion of the maxillary sinus

- Planning of multiple implants in both jaws
- Surgical templates and direct link to 3D navigated surgery\*
- Sinus analysis in children



## 6x $\emptyset$ 9 cm

### Covers the complete lower or upper jaw

- Planning of multiple implants in one jaw
- Surgical templates and direct link to 3D navigated surgery\*



## 9x $\emptyset$ 14 cm

### Illustration of the whole craniofacial area

- Illustration of the sinus maxillaries
- TMJ diagnostics



\* Provided by 3D planning SW or DTX Studio™

# Customised and fast: SMARTVIEW™ 2.0 and QUICKcompose™ for imaging at its best

With the KaVo OP 3D, the number of FOV sizes is almost unlimited. SMARTVIEW™ 2.0 offers the ability to select the FOV diameter and location and to adjust the FOV height between 5 and 9 cm in 5 mm steps based on the scout images.

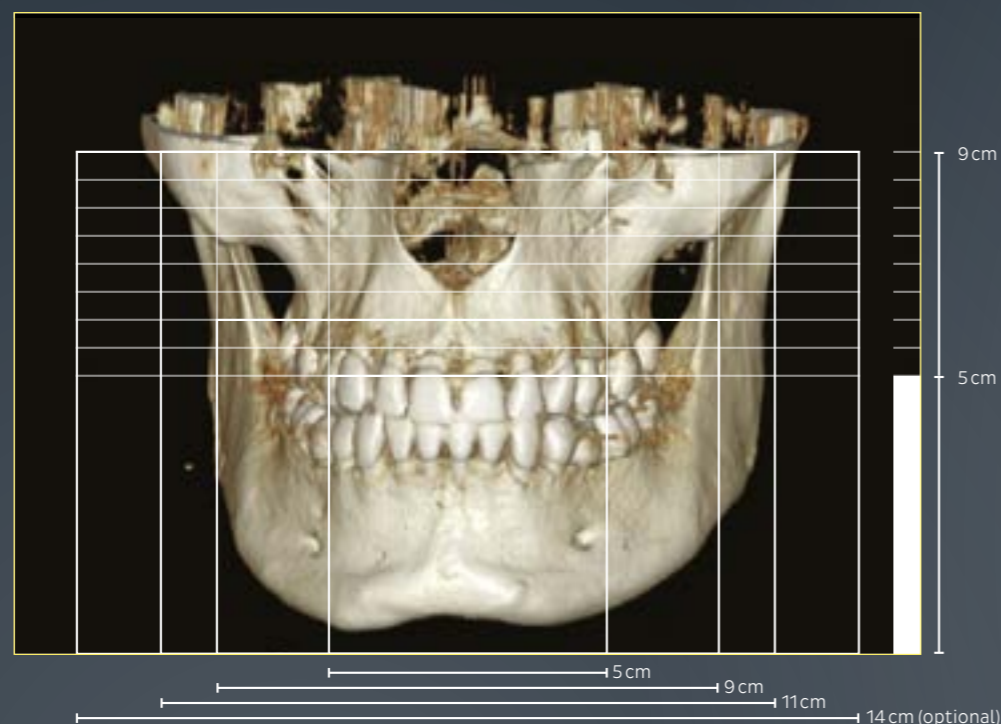

### SMARTVIEW™ 2.0: new level of control

The SMARTVIEW™ 2.0 user interface utilises two-dimensional scout images to allow choosing the most optimum FOV position height and diameter based on the clinical need.



### QUICKcompose™ feature: fast image review

Available for panoramic, cephalometric and 3D modalities, the QUICKcompose™ feature offers a quick preview of the captured image, allowing a timely evaluation. The image appears on the graphical user interface automatically as soon as the scan is completed.



# Designed for efficiency

Every feature of the KaVo OP 3D is designed to increase practice efficiency. Preparing the device for a scan is fast with an easy patient positioning system and intuitive graphical user interface. All imaging protocols are optimised for practice workflows.



**Intuitive operation, connected to the future**  
All functions can be easily and intuitively controlled in a time-saving way via PC or Mac\* through the practice's local network. Only the patient positioning is set on the device.

**Freedom to choose**  
The KaVo OP 3D is available in various configurations, expanding from panoramic-only through inclusion of cephalometric and 3D capabilities to complete 3-in-1 configuration (panoramic, cephalometric, 3D).



**ORTHOselect™ — for optimised 3D imaging workflow**  
The desired imaging area can be selected intuitively with ORTHOselect™ dental chart. Teeth can be selected individually or as a whole upper or lower jaw, or TMJ. The optimum Field of View is set automatically based on the selection.

**Grows with the needs of your practice**  
The KaVo OP 3D is designed to be upgradeable, allowing it to grow with the needs of your practice. The cephalometric or 3D imaging capabilities can be added also later on.

\* If used with DTX Studio™

# DTX Studio™ suite connecting treatments from beginning to end

With KaVo OP 3D you can benefit from DTX Studio™ suite\*, a single digital platform for dental treatments, that connects technologies and workflows – from image acquisition to diagnostics, planning, implant surgery and restoration.



### DTX Studio™ Clinic – only one software for all imaging data

- Use one piece of software to acquire and display together all imaging data from KaVo imaging devices, sensors, intraoral cameras and scanners.
- Boost the efficiency of your practice with the automated scheduling of scan assignments.
- Seamlessly proceed to diagnosis and treatment planning without the need to import or export data.

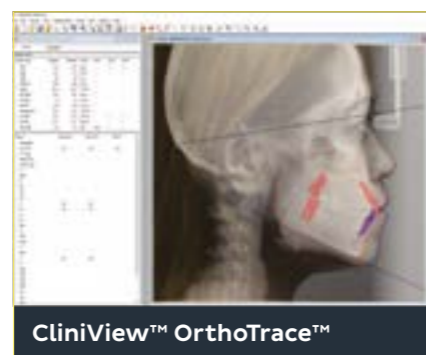

As an alternative, CliniView™ imaging software is available with an additional OrthoTrace™ option\*\* for cephalometric tracing needs.



For 3D imaging you can choose also 3D diagnostic software OnDemand3D™ or Invivo™ alternatives.\*\*

\* DTX Studio™ Clinic installation possible as soon as available in your region  
 \*\* Availability depending on offering and registrations in your region

# Technical specifications

### 2D/Panoramic

Image receptor	CMOS
Pixel size (sensor & image)	99 µm
Tube voltage	60–90 kV
Tube current	2–16 mA
Scan time	9 s
Image field height	147 mm
Imaging programs	Standard, segmented, paediatric, lat TMJ, bitewing

### 2D/Cephalometric

Image receptor	CMOS
Pixel size (sensor & image)	99 µm
Tube voltage	60–95 kV
Tube current	2–14 mA
Scan time	10.5 and 8.1 s
Image field height	180–223 mm
Image field width	160–260 mm
Imaging programs	Lateral and Paediatric Lateral with an adjustable field width, Posterior-Anterior (PA), Carpus*

### 3D/CBCT

Image detector	CMOS
Image voxel size	80–400 µm
Tube voltage	95 kV
Tube current	2–12.5 mA
Scan time	10–20 s
Image volume sizes (H x Ø)	5x 5, 6x 9, 9x 11, 9x 14 cm (optional) Volume height and location are adjustable through the SMARTVIEW™ 2.0 interface.

### Others

Tube focal spot	0.5 IEC 336 (IEC 60336/2005)
DICOM** support	Available as a software option

Easy wheelchair accessibility.  
 The device meets the RoHS Directive 2011/65/EU without any exemptions mentioned in Annex IV.

Details on the system requirements can be found on our Internet pages or can be requested at technical service.

\* Carpus imaging with optional holder

\*\* DICOM is the registered trademark of the National Electrical Manufacturers Association for their standard publications on the digital exchange of medical data.

## Dimensions

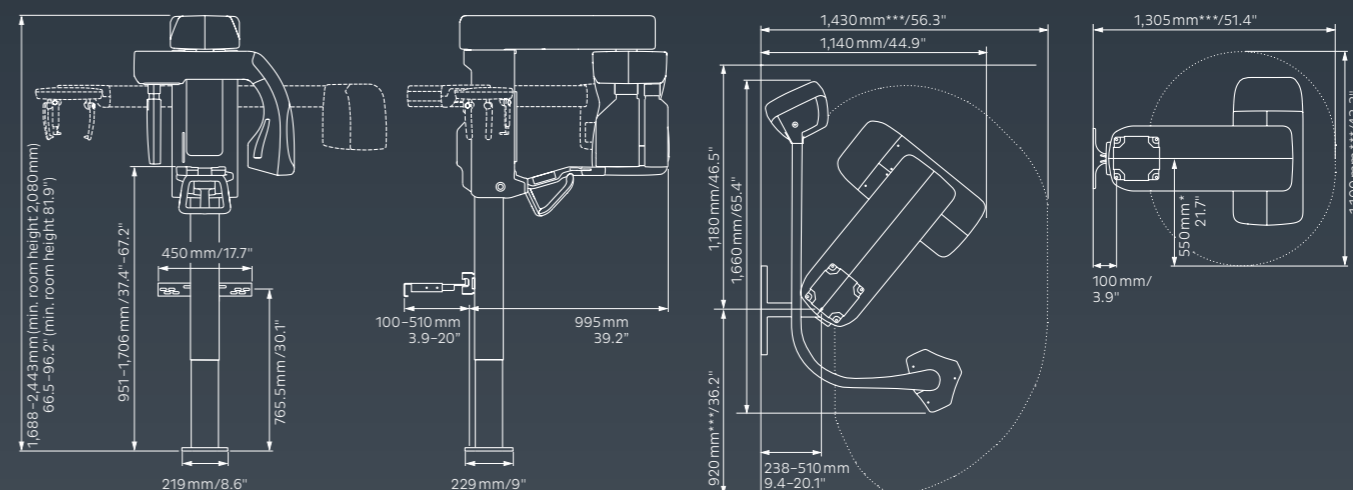

\*\*\* Device dimensions with imaging movements (minimum dimensions)